

mounting direction

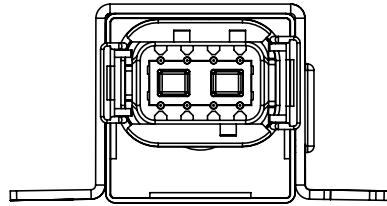

view of plug

BESCHREIBUNG

The Micro PLC CAN is a small control system for automotive applications. Free configuration and programmability offer a wide range of applications in the automotive sector. Control and readout are done via the CAN bus (ISO 11898-2). Freescale Processor with Flash technology (option of multiple programming).

TECHNICAL DATA

Housing	Plastic PA66GF30
Connector	DEUTSCH DTM04-08PA
Weight	75 g
Temperature range (ISO 16750-4 compliant)	-40°C up to +85 °C (at +85 °C not full load)
Environmental Protection	IP 6K8 in the correct installation position (plug down)
Current consumption	Depending on assembly: 23...27 mA
Over-current protection	1A + load
Total Inputs and outputs	Depending on assembly: 4 (2 inputs, 2 outputs) or 5 (2 inputs, 2 outputs)
Inputs	Depending on assembly: Analog input (0...11,4 V) Digital, positive encoder signals
Outputs	Depending on assembly: Digital, positive switching PWM output (3 Hz...500 Hz)
Operating voltage	Depending on assembly: 12 V (Code C) and/or 24 V (Code F) acc. to ISO 16750 – 2
Starting voltage	8,5 V (12 V variant) 16 V (24 V variant)
Overvoltage protection	≥ 33 V
Quiescent current	not available
Reverse polarity protection	Yes
CAN interface	CAN interface 2.0 A/B, ISO 11898-2:2003

REGULATORY APPROVALS AND TESTING

E1 approval	ECE R10 05 7362
Temperature range (ISO 16750-4 compliant)	Gem. ISO 16750 – 2 bzw. -4: Short circuit protection Jump start (12 V variante) Reverse polarity Interruption pin and connector Longtime overvoltage at TMax-20 °C Storage test at TMax and TMin Operation test at TMax and TMin Superimposed alternating voltage Slow decrease and increase of supply voltage Short-term voltage drop Reset behavior in case of voltage drop Acc to. ISO 7637 - 2: Puls 1, 2a, 2b, 3a, 3b

SOFTWARE/PROGRAMMING

Programming system	MRS Developers Studio MRS Developers Studio with built-in functions library, similar programming with FUP. Custom software blocks can be integrated into "C-code". Program memory is sufficient for about 300 basic logic components.
--------------------	---

INPUT FEATURES - SUMMARY

Pin C (8 only at S42 and S44)			Pin 15 (5)²		
Programmable as analog or digital input			Programmable as analog or digital input		
Resolution		12 Bit	Resolution		12 Bit
Accuracy		± 1% full scale	Accuracy		± 1% full scale
Voltage input 0...11.4 V (see A)	Input resistance	21,4 kΩ	Voltage input 0...11.4 V (see A)	Input resistance	21,4 kΩ
	Input frequency	fg ¹ = 65 Hz		Input frequency	fg ¹ = 65 Hz
	Accuracy	± 2 %		Accuracy	± 10 %
Digital input Positive (see B)	Input resistance	21,4 kΩ	Digital input Positive (see B)	Input resistance	21,4 kΩ
	Input frequency	fg ¹ = 65 Hz		Input frequency	fg ¹ = 65 Hz
	Turn-on threshold	6,5 V		Turn-on threshold	6,7 V
	Turn-off threshold	5 V		Turn-off threshold	6,6 V
Pin X (2 at S44 and 8 at S43)			Programmable as analog or digital input		
			Resolution		12 Bit
			Accuracy		± 1% full scale
			Voltage input 0...11.4 V (see A)	Input resistance	22,6 kΩ
				Input frequency	f _g ¹ = 60 Hz
				Accuracy	± 2 %
			Digital input Positive (see B)	Input resistance	22,6 kΩ
				Input frequency	f _g ¹ = 60 Hz
				Turn-on threshold	6,5 V
				Turn-off threshold	5 V
			Frequency input (see E)	Input resistance	22,6 kΩ
				Input frequency	≤ 2.2 kHz
				Turn-on threshold	6,5 V
				Turn-off threshold	5 V

¹ Cutoff frequency (-3 dB)

OUTPUT FEATURES - SUMMARY

Pin C (8)			Pin 87 (3), 87A (2) Highside driver-variant VNQ5050	
Digital output (open collector output)	max. performance	2 W ³	Wire fault diagnostics	Possible via current sense
	Protective circuit against inductive loads	not available, must be fused externally (free-wheeling diode)	Short circuit diagnostics	Possible via current sense
			Digital, positive switching (high side; see C)	Switching voltage 9-32 V DC
				Switching current see endurance tests
				Current sense via (ANA_I_OUT_87A ANA_I_OUT_87)
				Fusing load-dependent
Pin 87 (3), 87A (2) Relay variant (S43/S44)				
Load current (Relay, see E)	NO	15 A		
	NC (only S43)	10 A		
	Fuse protection	15 A		

² For variants with quiescent current and activated DO_POWER or CAN INH, the values may differ.

³ When using an LED, it glows due to the leakage current even when switched off.

ENDURANCE TEST HIGH-SIDE DRIVER VNQ5050 AT T_{MAX} = 85 °C

Measurement No.	87	87A	Total current	Passed
1	2,5 A	2,5 A	5 A	yes
2	3,5 A	3,5 A	7 A	yes
3	4 A	4 A	8 A	yes
4	4,5 A	4,5 A	9 A	yes
5	3 A	5 A	8 A	yes
6	6 A	2 A	8 A	yes
7	5 A	5 A	10 A	no, not suitable for the long term

PIN ASSIGNMENT POWER SUPPLY AND INTERFACES

Pin	Description	Pin	Description
1	Ground	6	CAN bus low
4	Operating voltage	7	CAN bus high
5	Contact 15/ignition/analog-digital input		

PIN ASSIGNMENT INPUTS AND OUTPUTS (DEPENDING ON ASSEMBLY)

Pin	Signal	Description	Pin	Signal	Description
2	OUT_87A ANA_I_OUT_87A	NC Output of relay or HSD output 87A with current sense	8	ANA_C D_ANA_C C	Analog input C 0...11,4 V or Digital input C or Digital output C (max. 2W)
3	OUT_87 ANA_I_OUT_87	NO output of relay or HSD output 87 with current sense		at S43: ANA_X D_ANA_X	Analog input X 0...11,4 V or Digital input X or Frequency input
	at S44: ANA_X D_ANA_X	Analog input X 0...11,4 V or Digital input X or Frequency input			
5	ANA_15 D_ANA_15	Analog input 15 0...11.4V or Digital input 15			

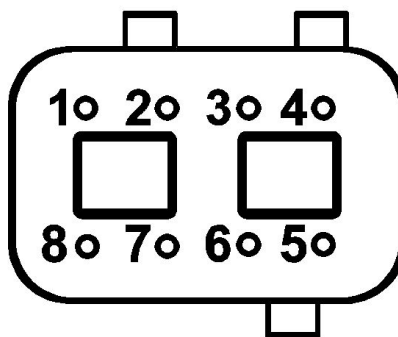

Pin assignment, bottom view

CONNECTION DIAGRAMS

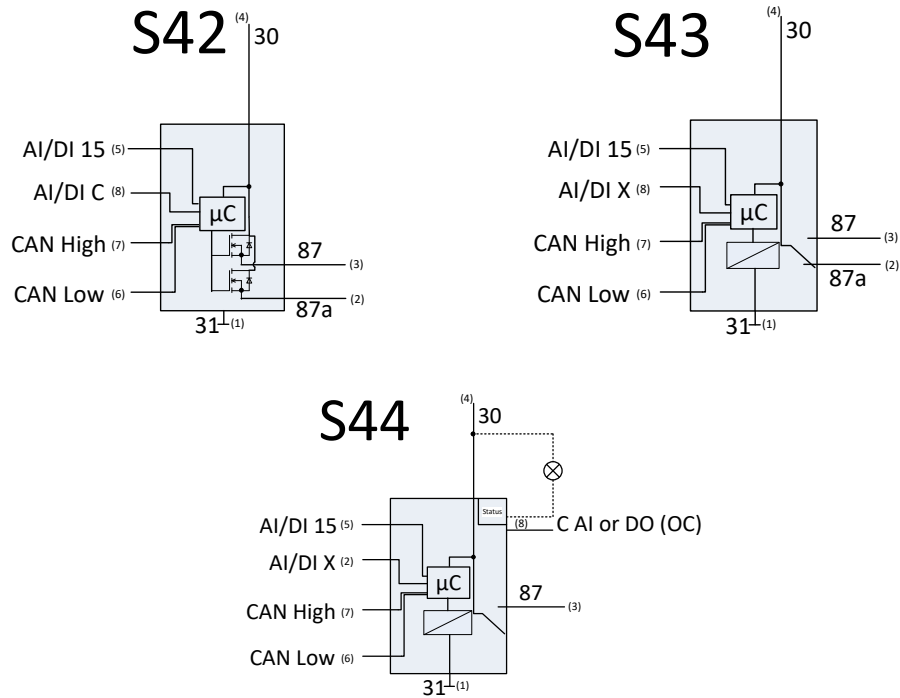

PIN FEATURE MAP

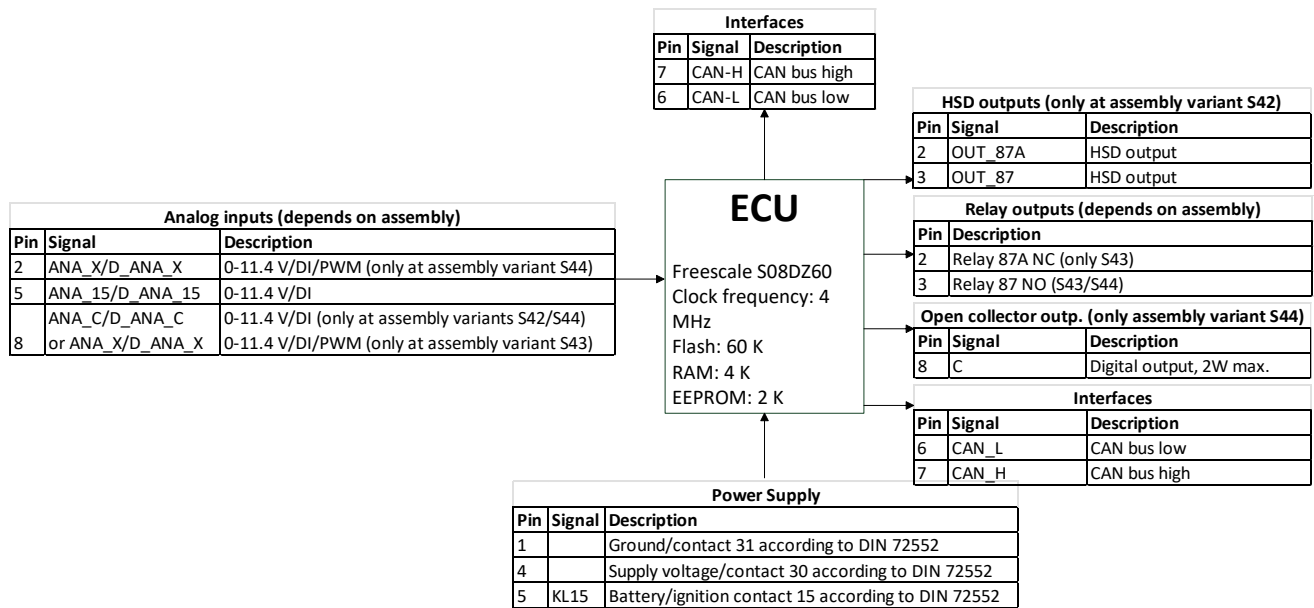

BLOCK DIAGRAM S42

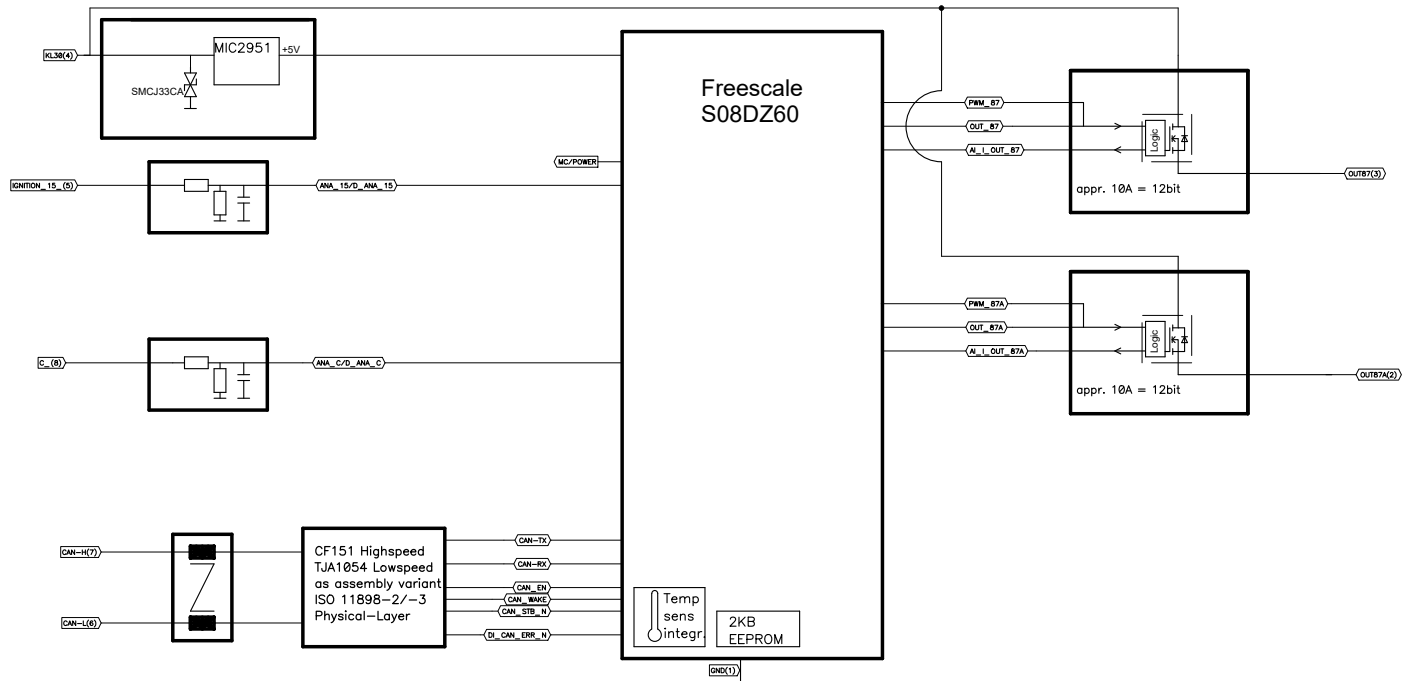

BLOCK DIAGRAM S43

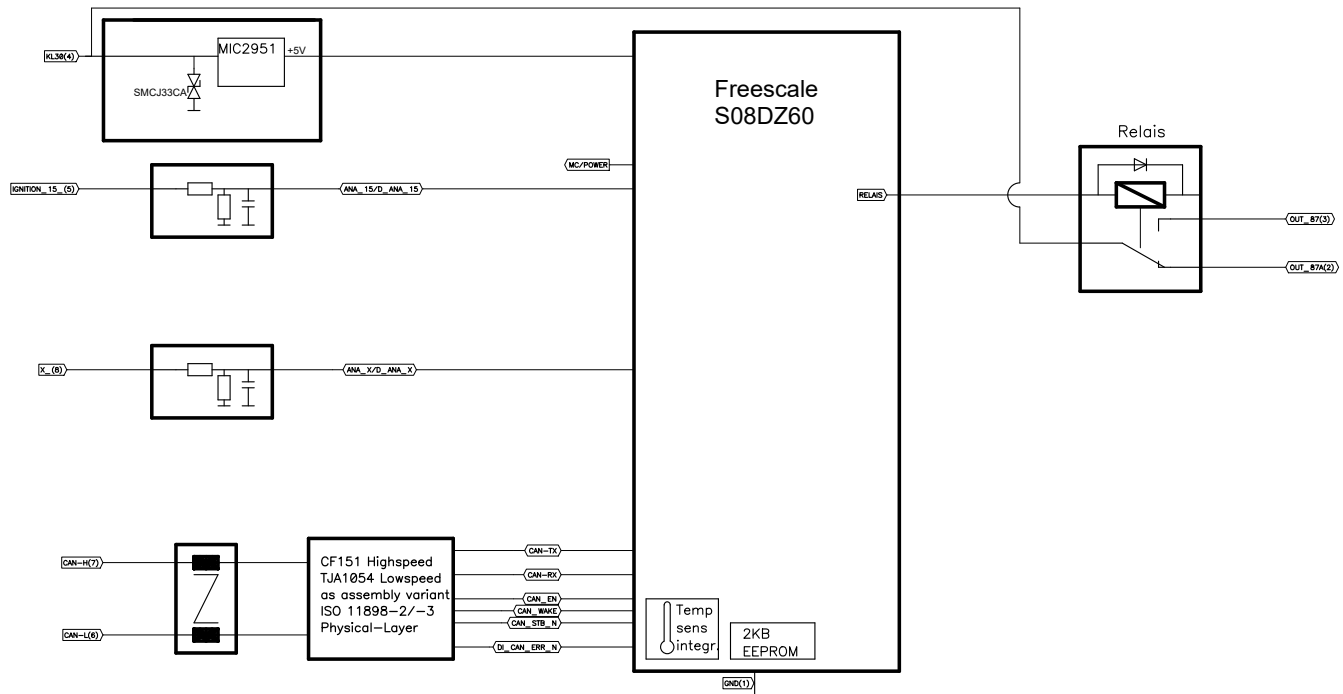

BLOCK DIAGRAM S44

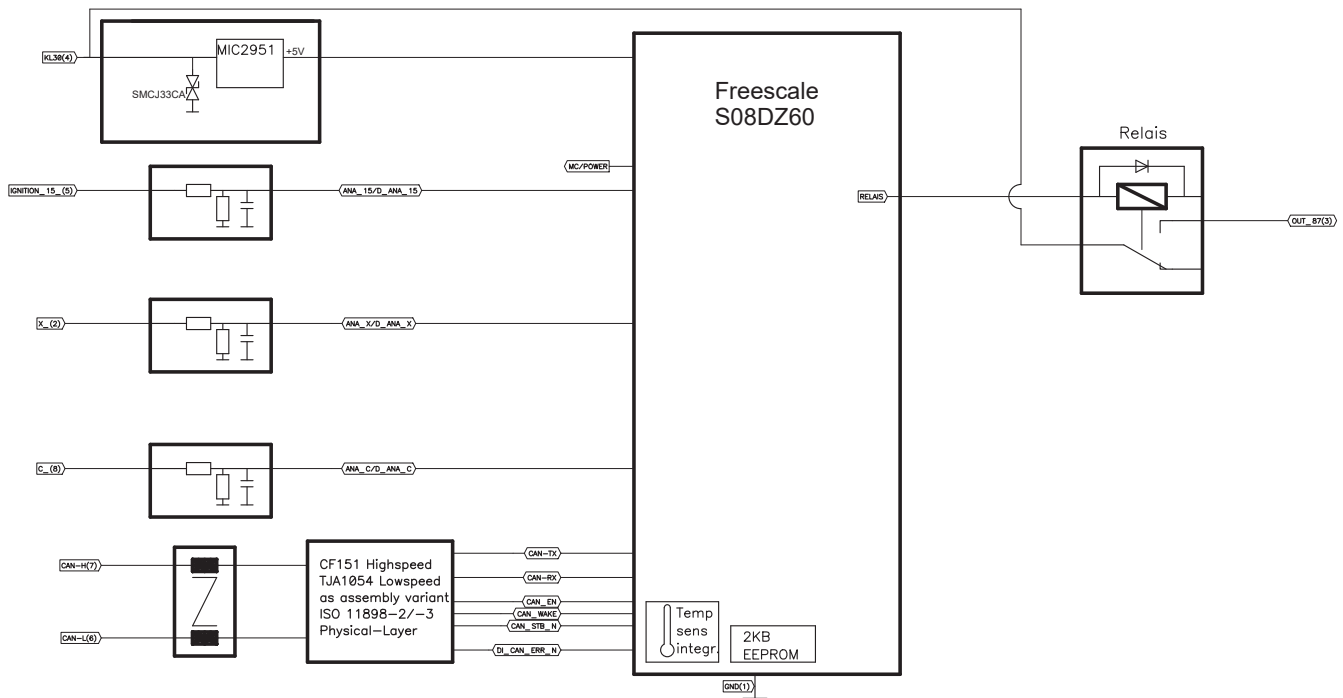

TECHNICAL DRAWING WITH CLAMPS IN MM [INCH]

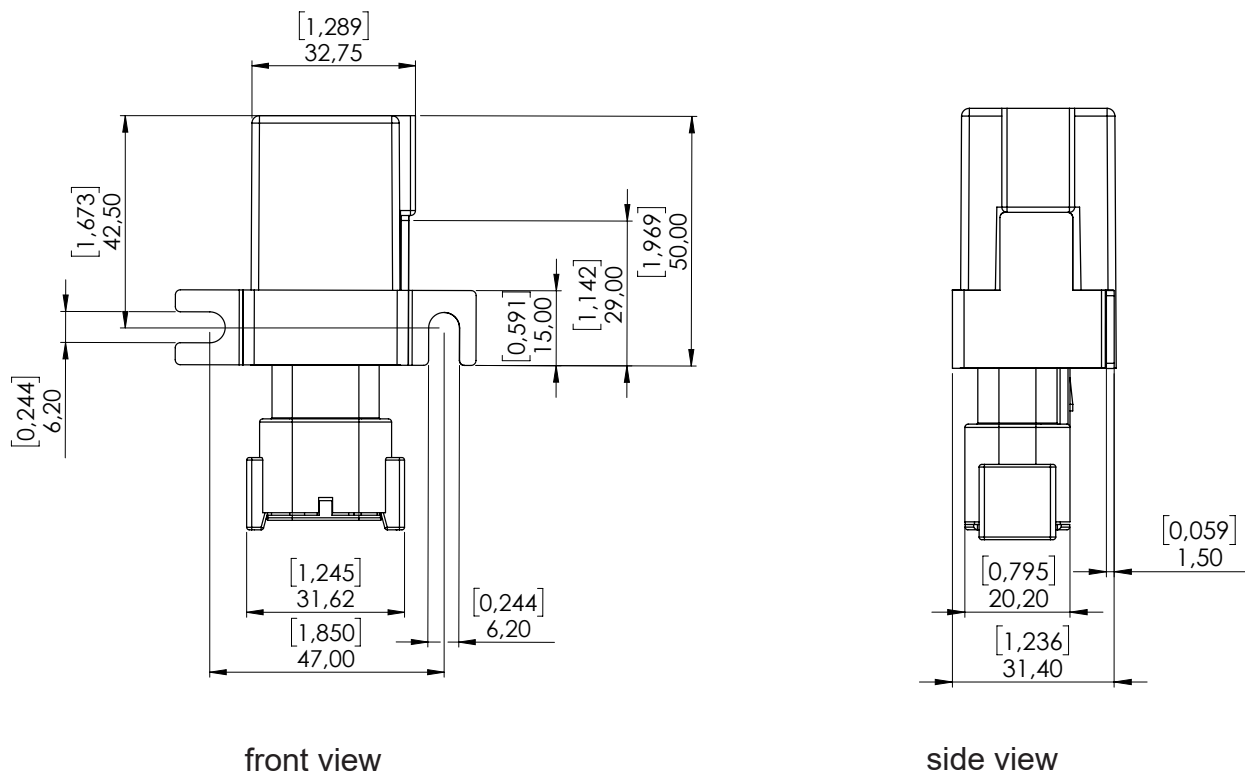



ASSEMBLY OPTIONS AND ORDER INFORMATION WITH HIGH SIDE OUTPUT

Order number	Supply voltage	Current consumption at 12 V	Current consumption at 24 V	Pin enumeration of inputs		Pin enumeration of outputs		CAN Bus	Features
				A Voltage 0 – 11.4 V	B Digital input	C High side output	D PWM ≤ 500 Hz		
1.107.910.001	9-32 V / S42	in mA ± 2 mA 23	in mA ± 2 mA 24	5, 8	5, 8	2, 3	2, 3	High-Speed X	

ASSEMBLY OPTIONS AND ORDER INFORMATION WITH RELAY OUTPUT

Order number	Supply voltage	Current consumption at 12 V	Pin enumeration of inputs			Pin enumeration of outputs	CAN Bus	Features
			A Voltage 0 – 11.4 V	E Frequency Hz	B Digital input			
1.107.710.01	12 V / S43	in mA ± 2 mA 27	5, 8	8	5, 8	2, 3	High-Speed X	
1.107.710.0E	12 V / S44	27	2, 5, 8	2	2, 5, 8	3	X	

ACCESSORIES

Description	Order number
Starter Kit μ PLC CAN	1.100.110.22
Programming tool MRS Developer Studio	1.100.100.09
PCAN-USB interface	105358
Programming cable set	302379



MANUFACTURER

MRS Electronic, Inc.
6680 Poe Avenue Suite 100
Dayton OH, 45414
USA

NOTES ON WIRING AND CABLE ROUTING

Hightside outputs may only be connected to ground.

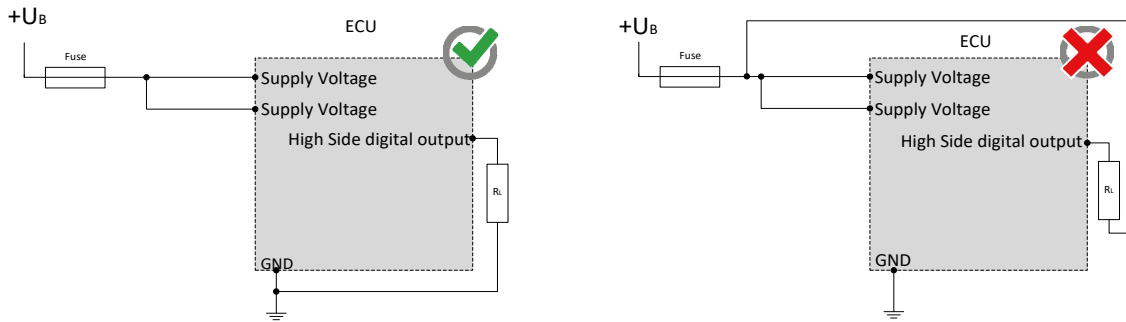

The control must be protected against overload (see performance data)

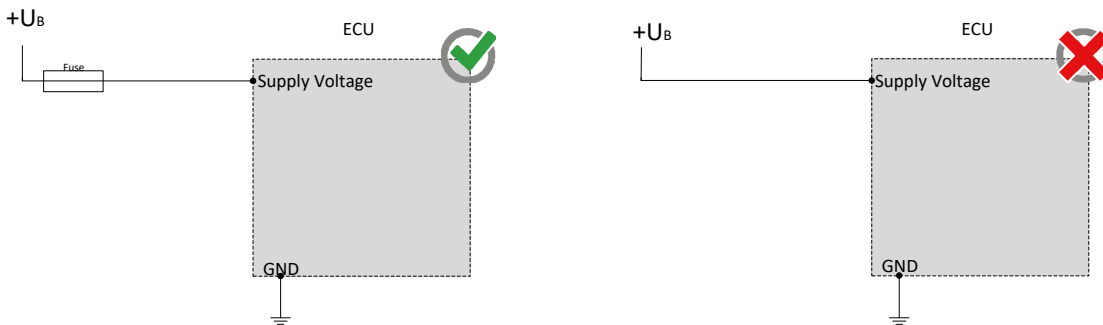

CAN bus communication is the main communication between the control unit and the vehicle. Therefore, connect the CAN bus with special care and check the correct communication with the vehicle to avoid undesired behavior.

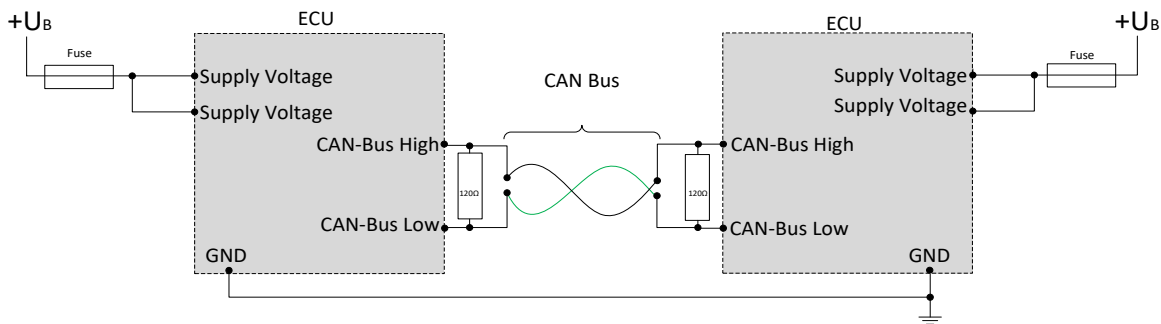

PWM outputs may not be connected with each other or bypassed.

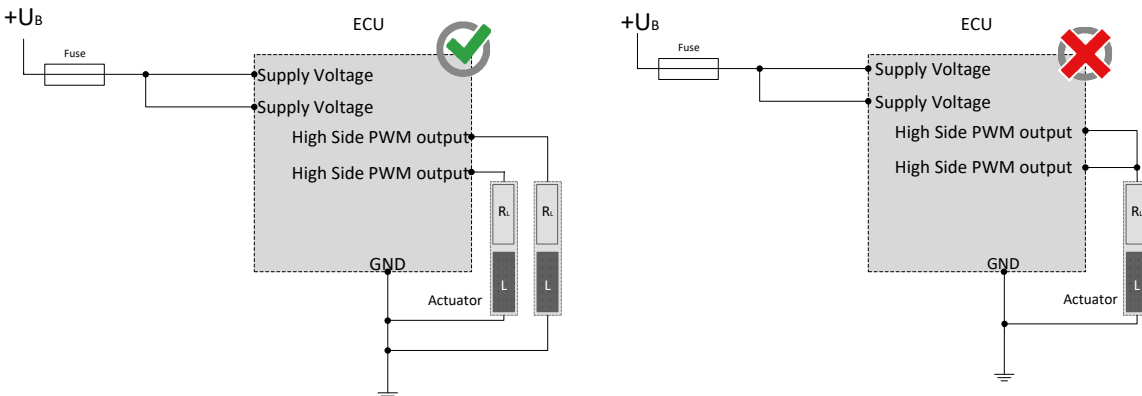

SAFETY AND INSTALLATION INFORMATION

It is essential to read the instructions in full thoroughly before working with the device.

Please note and comply with the instructions in the operating instructions and the information in the device data sheet, see www.mrs-electronic.com

Staff qualification: Only staff with the appropriate qualifications may work on this device or in its proximity.

SAFETY



WARNING! Danger as a result of a malfunction of the entire system.

Unforeseen reactions or malfunctions of the entire system may jeopardise the safety of people or the machine.

- Ensure that the device is equipped with the correct software and that the wiring and settings on the hardware are appropriate.



WARNING! Danger as a result of unprotected moving components.

Unforeseen dangers may occur from the entire system when putting the device into operation and maintaining it.

- Switch the entire system off before carrying out any work and prevent it from unintentionally switching back on.
- Before putting the device into operation, ensure that the entire system and parts of the system are safe.
- The device should never be connected or separated under load or voltage.



CAUTION! Risk of burns from the housing.

The temperature of the device housing may be elevated.

- Do not touch the housing and let all system components cool before working on the system.

PROPER USE

The device is used to control or switch one or more electrical systems or sub-systems in motor vehicles and machines and may only be used for this purpose. The device may only be used in an industrial setting.



WARNING! Danger caused by incorrect use.

The device is only intended for use in motor vehicles and machines.

- Use in safety-related system parts for personal protection is not permitted.
- Do not use the device in areas where there is a risk of explosion.

Correct use:

- operating the device within the operating areas specified and approved in the associated data sheet.
- strict compliance with these instructions and no other actions which may jeopardise the safety of individuals or the functionality of the device.

Obligations of the manufacturer of entire systems

It is necessary to ensure that only functional devices are used. If devices fail or malfunction, they must be replaced immediately.

System developments, installation and the putting into operation of electrical systems may only be carried out by trained and experienced staff who are sufficiently familiar with the handling of the components used and the entire system.

It is necessary to ensure that the wiring and programming of the device does not lead to safety-related malfunctions of the entire system in the event of a failure or a malfunction. System behaviour of this type can lead to a danger to life or high levels of material damage.

The manufacturer of the entire system is responsible for the correct connection of the entire periphery (e.g. cable cross sections, correct selection/connection of sensors/actuators).

Opening the device, making changes to the device and carrying out repairs are all prohibited. Changes or repairs made to the cabling can lead to dangerous malfunctions. Repairs may only be carried out by MRS.

Installation

The installation location must be selected so the device is exposed to as low a mechanical and thermal load as possible. The device may not be exposed to any chemical loads.

Install the device in such a manner that the plugs point downwards. This means condensation can flow off the device. Single seals on the cables/leads must be used to ensure that no water gets into the device.

Putting into operation

The device may only be put into operation by qualified staff. This may only occur when the status of the entire system corresponds to the applicable guidelines and regulations.

FAULT CORRECTION AND MAINTENANCE



NOTE The device is maintenance-free and may not be opened.

- If the device has damage to the housing, latches, seals or flat plugs, it must be taken out of operation.

Fault correction and cleaning work may only be carried out with the power turned off. Remove the device to correct faults and to clean it.

Check the integrity of the housing and all flat plugs, connections and pins for mechanical damage, damage caused by overheating, insulation damage and corrosion. In the event of faulty switching, check the software, switches and settings.

Do not clean the device with high pressure cleaners or steam jets. Do not use aggressive solvents or abrasive substances.